

DR MATRIX

High Power ■ High Energy Saving



www.darwinmotion.com

DESIGNED IN AUSTRALIA-ASSEMBLE IN INDIA



ABOUT US

CUTTING
EDGE
SERVICES

RELIABLE
SOLUTIONS

PROVEN
PERFORMANCE

PARTNER
IN
PROGRESS

DARWIN MOTION is an Australia-based company - your ultimate destination for cutting-edge frequency drives, servo drives, and more. We deliver top-notch motion control solutions for businesses. Through innovation, we ensure your success and growth. Get a taste of motion technology at its finest by partnering with us. Let's elevate your business together!



INNOVATIVE

129

design

SUPPORTIVE

1,000+

drives application
specialists annually

EXPERIENCED

1.5M

drives sold
annually

- 1** **Urbanization**
Greater demand for water and wastewater solutions
- 2** **Industrialization**
Greater need for connectivity and automation
- 3** **Digitization**
Big data capability provides new avenues for efficiencies
- 4** **Scarcity of resources**
Demand for efficient use of resources

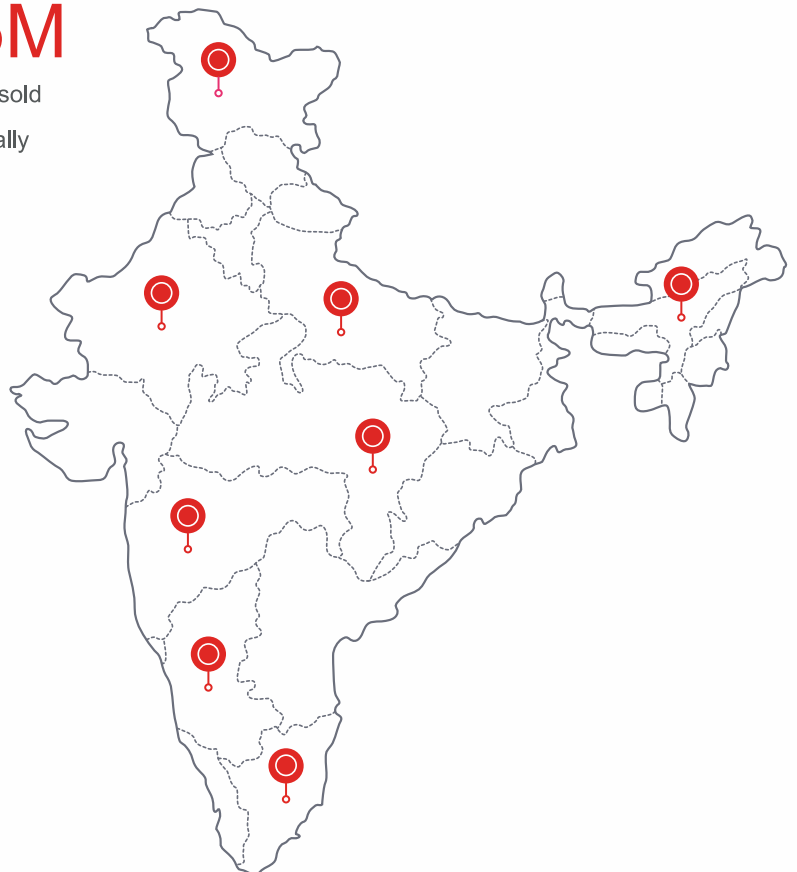

FEATURES



High Torque Drive

50 - 60 HZ + 5 HZ

Reduce  emission



Conformal Coating

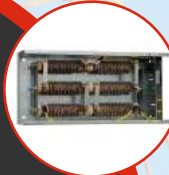



Reliable Braking Function



Smart Keypad

ATMOSPHERE

 -20°
 45°



High Anti Interference EMC Filter

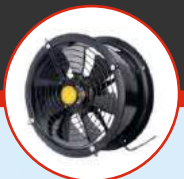

Removable Fan



Hot Pluggable LCP

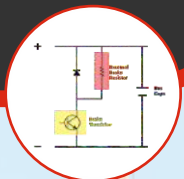

DC Reactor

PROTECTION



Over Current



Over Voltage



Short Circuit



Over Load Protection



Over Heating



Under Voltage



Input & Output Phase Loss

APPLICATIONS MACRO



HVAC



FAN



PUMP



COMPRESSOR



TEXTILE WINDER



WINCH HOIST

ACCURATE AND COMPREHENSIVE AUTO TUNING FUNCTION



Comprehensive Motor Drive Technology

- Support drive control of all motors (three-phase synchronous, permanent magnet synchronous).
- Support the speed and torque control modes.
- The frequency converter equipped with the synchronous motor delivers good energy-saving effects.

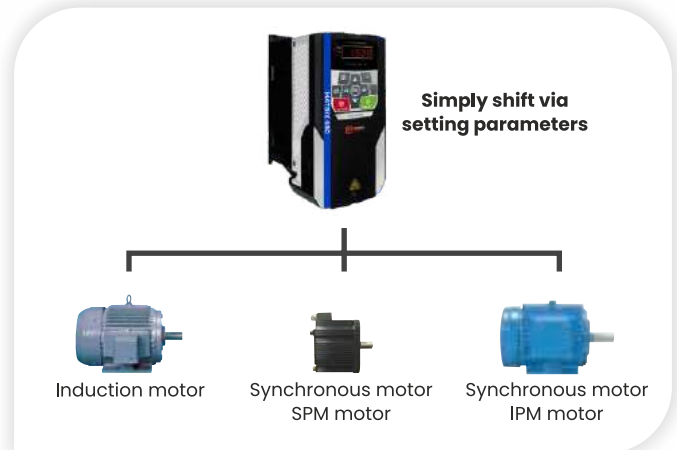

Built-in Servo Function

- The built-in servo positioning is adopted for the device. When the PG vector control is available, the device supports control over positions including zero servo, principal axis orientation (4 orientation positions), simple carry control (8 carryovers setting) and pulse train position.
- Servo functions such as spindle positioning at any angle and stop at a specified angle can be realized.
- It can be used in most servo application fields.

Accurate and Comprehensive Auto-turning Function

- The frequency converter can accomplish motor parameter auto-turning accurately, it will be more convenient to operate & commissioning and offers higher control precision and response speed.
- The comprehensive and rich Auto-turning functions cover various motor Auto-turning and mechanical Auto-turning functions.

Rich Fieldbus Communication

- Built in RS-485
- Built-in Modbus-RTU as standard
- Support several kinds of field bus communication protocols (PROFIBUS-DP, CANopen, Profinet, EtherCAT)

Modular DESIGN



ACCURATE AND COMPREHENSIVE AUTO TUNING FUNCTION

Wide Speed Range, High Steady-speed Precision

- Speed range :
 - Open-loop vector : 1 : 200
 - Close-loop vector : 1 : 3000
- Steady-speed precision :
 - Open-loop vector : 10% rated slip
 - Close-loop vector : $\pm 0.01\%$

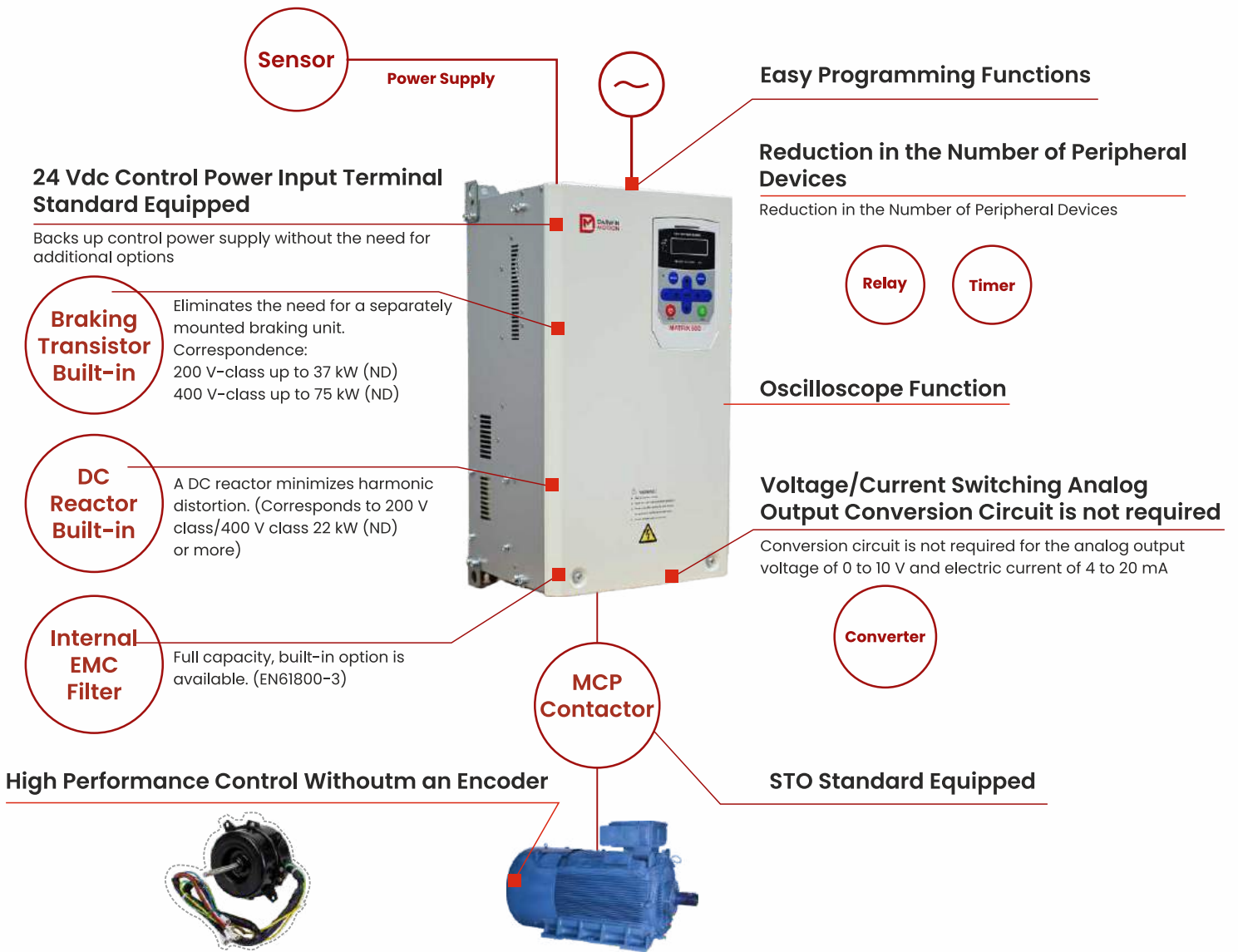
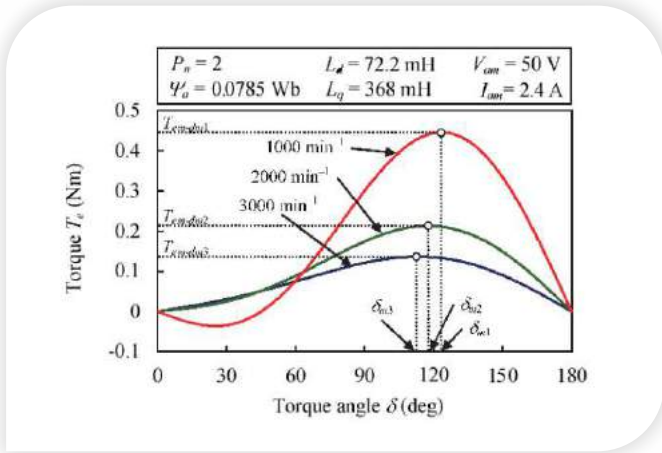

NAMING RULE OF 500, 680, 350

DR XXX - XX - XXXG / XXXP - 3B - XXXX

DRIVE PRODUCT SERIES

- 680/680L SVC& FVC high performance vector control inverter suitable for asynchronous/ permanent magnet synchronous motor
- 680S high power servo drive SVC high performance vector control inverter suitable for asynchronous/ permanent magnet synchronous motor
- 350/ 350L SVC& FVC vector control inverter suitable for asynchronous/ permanent magnet synchronous motor
- DR500/DR500L SVC/ scalar control inverter suitable for asynchronous/ permanent magnet synchronous motor
- 355/ 355L SVC/ scalar control inverter suitable for asynchronous/ permanent magnet synchronous motor

Non-standard customized model

- B : Built-in brake chopper
- /B : Optional built-in brake chopper
- None : Without built-in brake chopper

VOLTAGE CLASS

0	: Single phase	110v
1	: Single phase	220 v
2	: Three phase	220v
3	: Three phase	380v
4	: Three phase	500 v
5	: Three phase	690 v

Rated power in general applications

0K4	...	5K5	...	018	...
0.4kW	...	5.5kW	...	18.5kW	...

DIMENSIONS

01: first dimension and structure
02: second dimension and structure... and so on

Rated power in heavy load applications

0K4	...	5K5	...	018	...
0.4kW	...	5.5kW	...	18.5kW	...



MATRIX DRIVE



- Excellent performance for speed & torque closed loop control
- Comprehensive and systematic protection functions
- Intelligent LCD keyboard included in standard configuration
- Built-in various industry application standard macros
- Support multiple encoders for high performance and high precision control

MATRIX500

GENERAL PURPOSE DRIVE

High Torque Mode Drive

220-240V	0.4-75KW
380-500V	0.75-800KW
690V	45KW-1000KW



Energy Saving Mode



PM Motor



Reluctant Motor



IE1,IE2,IE3,IE4,IE5 MOTOR



DC REACTOR



EMC FILTER



STO - SAFE TORQUE OFF

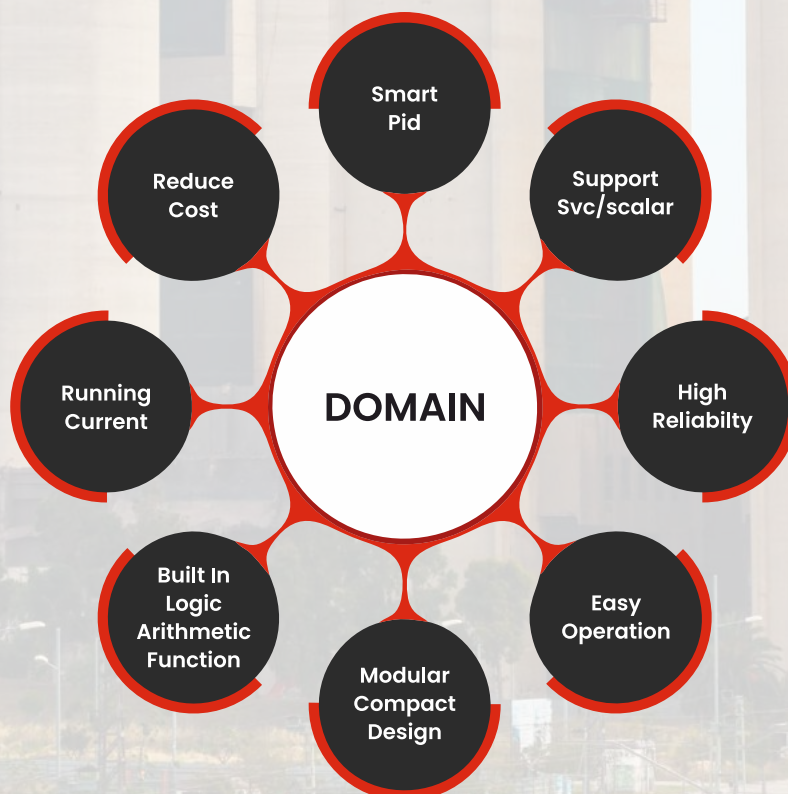

TECHNICAL DATA OF MATRIX 500

Item	Specification and Technical Data
Main Power Connection	Input voltage U1 220V/380V/500/690V±15% ;signal/three-phase power
	Input frequency f1 50...60Hz ±5Hz
	Output voltage U2 0...U1 (V)(The maximum output voltage equals the input power voltage.)
	Output frequency f2 0-1000Hz
	Carrier frequency 2-8 KHz (The device can intelligently and automatically make optimal adjustment according to load characteristics and drive temperature.)
	Input voltage unbalance degree Maximum: ±3% of rated inter-phase input voltage
	Efficiency ≈ 98% (when operating at rated power)
Basic Functions	Speed range 0-1000Hz (0~30000 rpm, 60000rpm is optional)
	Resolution of given speed Digital setting: 1RPM Analog setting: 0.025% of maximum RPM
	Control Mode SVC control / FVC vector control
	Starting speed 200% @ 0.25Hz@ SVC control 200% @0Hz@ FVC control
	Speed ratio 1 : 200 @ SVC control 1 : 3000 @ FVC control
	Steady-speed precision ±0.5% @ SVC control ±0.01% @ FVC control
	Overload capacity Heavy load application: 60s at 150% rated current @40°C. The time depends on the drive temperature under other conditions. General application: 60s at 120% rated current @40°C. The time depends on the drive temperature under other conditions.
	Torque boost Automatic torque boost. Manual torque boost 0.1%-30%
	Acceleration and deceleration curves straight-line or S-curve acceleration and deceleration mode Two acceleration time values. The acceleration and deceleration time range : 0.0s-650.00s
	Simple PLC function Achieve operation of up-to-16-stages speed(via built-in PLC or control terminals)
	Built-in PID Conveniently achieve the process control close-loop control system
Automatic voltage regulation (AVR) When the grid voltage changes, the device automatically maintains constant output voltage.	
Overvoltage and overcurrent stall control The current and voltage are automatically limited during running to avoid jump faults due to frequent over current and over voltage.	
Enhancements	Torque limiting and control The torque is automatically limited operating (to avoid frequent over current jumping fault due to too large torque).
	Protection function Output short circuit protection, input & output phase loss protection, over current protection, over voltage protection, under voltage protection, overheat protection, overload protection, brake chopper overload protection, brake chopper shortcircuit protection, brake resistor overload protection
	Non-stop during transient interruption Timing control function. The time range and precision is 0.0-6500.0(min).
I/O Input Output Interface	Command input mode Control keyboard input, control terminal input, bus communication input, which can be switched mutually.
	Speed reference mode Digital giving, analog voltage (current) giving, pulse giving, bus communication giving and PID giving, which are mutually switched.
	Input terminal (input) The followings are included in standard configuration : 6 (F0) / 7 (F1 and above) digital input terminals, where, DI6 (F0) DI7 (F1 and above)supports the maximum of 50 kHz high-speed pulse input. 2 (F0) / 3 (F1 and above) analog input terminals (where, at least 2 supports 0-10V voltage input or 0-20 mA or 4-20mA voltage input) The followings are extended as cards : 5 digital input terminals 2 analog input terminals, supporting input of -10V to+10V voltage (Optional)
	Output terminal (output) The followings are included in standard configuration: 1 high-speed pulse output terminal (supporting 0-50 kHz square signal output) 1 (F0) / 2 (F1 and above) digital output terminals 1 (F0) / 2 (F1 and above) relay output terminals 1 (F0) / 2 (F1 and above) analog output terminals (supporting 0-10V voltage output or 0- 20mA or 4-20 mA voltage output)

TECHNICAL DATA OF MATRIX 500 |▶

Item		Specification and Technical Data
Display and Control	Man-machine interface	F0 built in fixed LED keypad, and LCD keypad is optional. F1 and above is built in standard smart LCD keyboard, LED keypad is optional
	Parameters duplicating	Rapidly duplicating parameters via the LCD control keyboard
Application environment	Application site	Indoor, free of direct sunshine, dusts, corrosive gases, flammable gases, oil mist, water vapor, drip or salts
	Altitude	At 0-1000m ; When the altitude is 1000-4000m, the capacity is reduced by 1% as the altitude rises by 100m. (consult professionals for more accurate values)
	Operation ambient temperature	-10℃ to +40℃ (when the ambient temperature is 40℃-55℃, the drive is automatically derated to achieve self-protection)
	Relative humidity	Less than 95%RH. No droplets condensed (condensation)
	Sinusoidal vibration	(IEC 60068-2/-6.TestFc) Max.0.1mm (5 to 13.2Hz) ; max.7m/s ² (13.2 to 100 Hz) sinusoidal vibration (F0-F7) Max.0.1mm (10 to 57Hz) ; max.10m/s ² (57 to 150 Hz) sinusoidal vibration (F8-F9)
	Impact	Not allowed (during operation); maximum 100m/s, 11ms (during storage and transportation with packing)
	Free fall (Max.)	Not allowed (during operation); with packing : 100cm @F0-F2A, 76cm @F3-F4, 46cm @F5-F7, 15cm @F8-F9
	Storage & transportation temperature	-40℃ to +70℃ (-40 to +158°F)
Protection grade	Ip20 (UL-open type), (the medium cavity with air vents on two sides for some F0** models) Electrical cavity full closed design for small- and medium-power models, Top/Left and right sides can reach IP40	
Cooling mode	Forced air cooling of the interior fan. The air flows from bottom to top. Air-cooled radiator.	
Application standard	IEC 61800-3, IEC 61800-5-1; GB12668 (see the nameplate for details).	

SELECTION OF DR 500



- High reliability
- precision control
- Intelligent LCD keyboard included in standard configuration
- Modular compact structure design
- Support SVC vector control
- Support permanent magnet synchronous motor/asynchronous motor control
- Support several kinds of field bus communication protocols (PROFIBUS-DP, CANopen, Profinet, EtherCAT)
- Built-in logic arithmetic function

DIAGRAM OF MATRIX 500

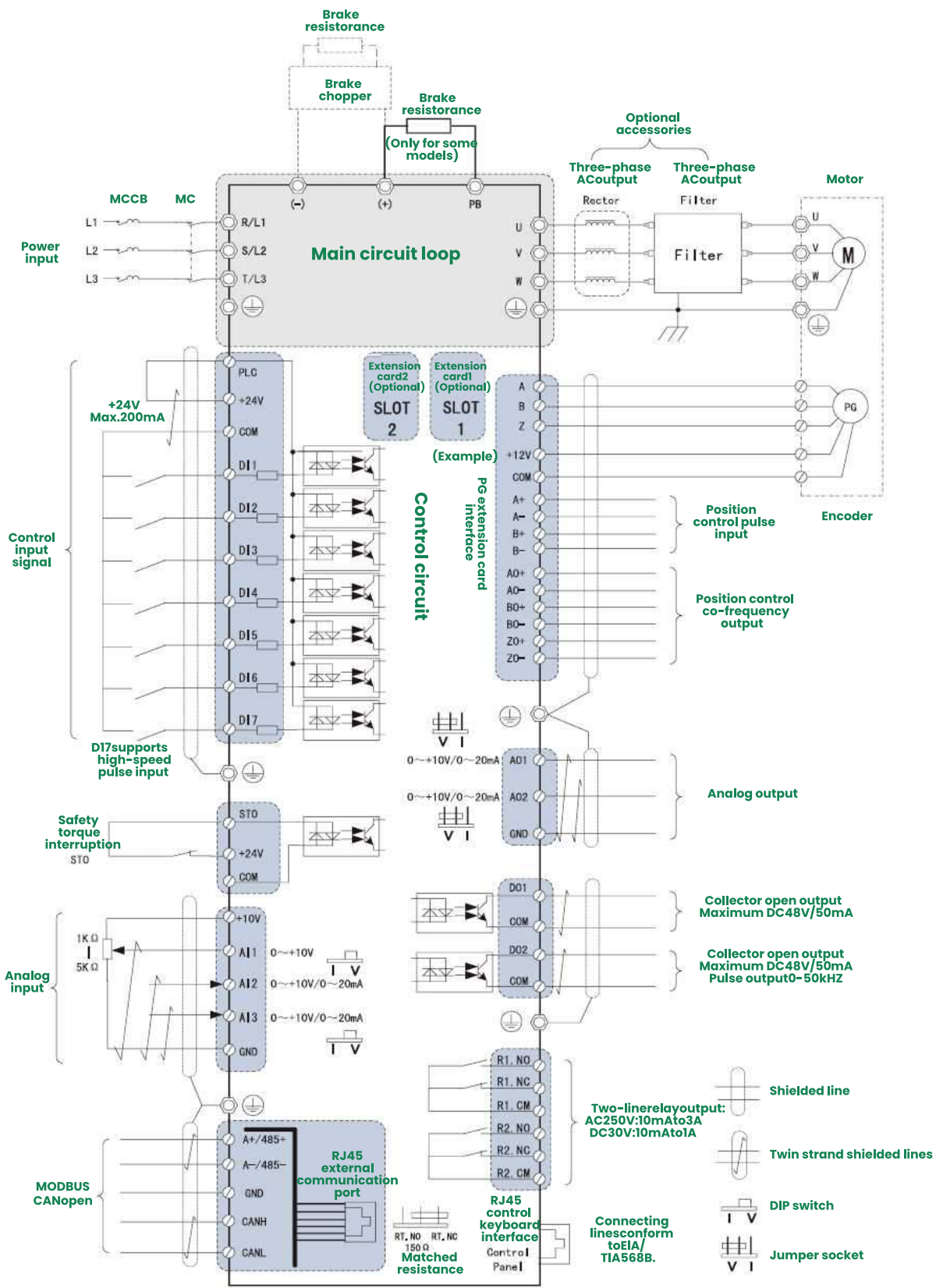

SELECTION OF DR 500

220V 3PH RATED VOLTAGE (ADAPT TO THE WORKING VOLTAGE RANGE 208 ~ 240V + 15%)

Model Code	Rated Value		General Load Application		Heavy Load Application		Noise Level	Heat Radiation	Air Volume	Dimension
	In(A)	Imax(A)	ILd(A)	PLd(kW)	Ihd (A)	Phd(kW)	dBA	W	m/h	
DR500-01-0K4G/0K7P-2B	5.2	7	5	0.75	2.5	0.37	45	40	89	F1
DR500-01-0K7G/1K5P-2B	6.3	9	6	1.5	4.2	0.75	45	76	89	
DR500-01-1K5G/2K2P-2B	10.5	15	9.8	2.2	5.6	1.5	45	97	89	
DR500-01-2K2G/4K0P-2B	18.2	25	17.5	4	14.5	2.2	45	172	130	
DR500-02-4K0G/5K5P-2B	26	36	25	5.5	17.6	4	45	325	130	F2
DR500-02-5K5G-2B	28	35	/	/	25	5.5	45	420	130	F2A
DR500-02A-5K5G/7K5P-2B	37	50	35	7.5	25	5.5	52	470	175	
DR500-02A-7K5G/011P-2B	41	57	38.6	11	35	7.5	52	550	175	
DR500-03-7K5G/011P-2B	41	57	38.6	11	35	7.5	57	550	306	F3
DR500-03-011G/015P-2B	63.5	89	61	15	48	11	57	890	306	F4
DR500-04-015G/018P-2	78	109	75	18.5	66	15	60	1114	610	
DR500-04-018G/022P-2	95	133	91	22	79	18.5	60	1140	610	
DR500-04-022G/030P-2	120	168	115	30	94	22	60	1200	610	
DR500-05-030G/037P-2	162	227	155	37	116	30	60	1440	610	F5
DR500-05-037G/045P-2	185	222	178	45	160	37	60	1940	610	
DR500-05-045G/055P-2	225	270	215	55	179	45	67	2200	850	
DR500-06-055G/075P-2	272	326	261	75	215	55	68	3300	1275	

Note: Rated power is measured under rated voltage 220V

380V 3PH RATED VOLTAGE (ADAPT TO THE WORKING VOLTAGE RANGE 380~460V +15%)

Model Code	Rated Value		General Load Application		Heavy Load Application		Noise Level	Heat Radiation	Air Volume	Dimension
	In(A)	Imax(A)	ILd(A)	PLd(kW)	Ihd (A)	Phd(kW)	dBA	W	m/h	
DR500/500L-01-0K7G/1K5P-3B	5.2	7	5	1.5	2.5	0.75	45	40	89	F1
DR500/500L-01-1K5G/2K2P-3B	6.3	9	6	2.2	4.2	1.5	45	76	89	
DR500/500L-01-2K2G/4K0P-3B	10.5	15	9.8	4	5.6	2.2	45	97	89	
DR500/500L-01-4K0G/5K5P-3B	14	20	13.5	5.5	10.5	4	45	172	89	
DR500/500L-01-5K5G/7K5P-3B	18.2	25	17.5	7.5	14.5	5.5	45	210	130	F2
DR500/500L-02-7K5G/011P-3B	26	36	25	11	17.6	7.5	45	325	130	
DR500/500L-02-011G-3B	28	35	26	15	25	11	45	420	130	
DR500/500L-02A-011G/015P-3B	37	50	35	15	25	11	52	470	175	
DR500/500L-02A-015G/018P-3B	41	57	38.6	18.5	35	15	52	550	175	F2A
DR500/500L-03-015G/018P-3B	41	57	38.6	18.5	35	15	57	550	306	F3
DR500/500L-03-018G/022P-3B	48	67	46	22	41	18.5	57	660	306	
DR500/500L-03-022G/030P-3B	63.5	89	61	30	48	22	57	890	306	
DR500/500L-04-030G/037P-3/B	78	109	75	37	66	30	60	1114	610	
DR500/500L-04-037G/045P-3/B	95	133	91	45	79	37	60	1140	610	F4
DR500/500L-04-045G/055P-3/B	120	168	115	55	94	45	60	1200	610	
DR500/500L-05-055G/075P-3/B	162	227	155	75	116	55	60	1440	610	
DR500/500L-05-075G/090P-3/B	185	240	178	90	160	75	60	1940	610	
DR500/500L-05-090G/110P-3/B	225	270	215	110	179	90	67	2200	850	F5
DR500/500L-06-110G/132P-3	272	326	261	132	215	110	68	3300	1275	
DR500/500L-06-132G/160P-3	320	384	310	160	259	132	68	3850	1275	
DR500/500L-07-160G/200P-3	375	450	387	200	314	160	75	4100	1800	
DR500/500L-07-200G/220P-3	450	540	427	220	387	200	75	4600	1800	F7
DR500/500L-07-220G/250P-3	487	584	450	250	427	220	75	5100	1800	
DR500/500L-08-250G/280P-3	546	628	525	280	481	250	68	5782	2190	
DR500/500L-08-280G/315P-3	624	718	600	315	550	280	68	6252	2190	
DR500/500L-08-315G/355P-3	686	789	660	355	616	315	68	7866	2190	F8
DR500/500L-09-355G/400P-3	760	874	720	400	650	355	75	9100	2700	
DR500/500L-09-400G/450P-3	865	995	810	450	720	400	75	9900	2700	
DR500/500L-09-450G/500P-3	950	1093	870	500	810	450	75	10500	2700	
DR500/500L-09-500G/560P-3	1100	1265	980	560	870	500	75	11500	2700	F9
DR500/500L-09-560G/630P-3	1200	1380	1060	630	980	560	75	12600	2700	
DR500/500L-10-630G/710P-3	1350	1450	1320	710	1200	630	75	14500	3600	
DR500/500L-10-710G/800P-3	1500	1600	1450	800	1320	710	75	16800	3600	

Note: Rated power is measured under rated voltage 380V

500V 3PH RATED VOLTAGE (ADAPT TO THE WORKING VOLTAGE RANGE 480~525V ±15%)

Model Code	Rated Value		General Load Application		Heavy Load Application		Noise Level	Heat Radiation	Air Volume	Dimension
	In(A)	Imax(A)	ILd(A)	PLd(kW)	Ihd (A)	Phd(kW)	dBA	W	m/h	
DR500-04-015G/018P-5	35	64	33	18.5	27	15	60	890	610	F4
DR500-04-018G/022P-5	44	70	41	22	35	18.5	60	1114	610	
DR500-04-022G/030P-5	49	71	48	30	45	22	60	1140	610	
DR500-04-030G/037P-5	61	104	58	37	52	30	60	1200	610	
DR500-05-037G/045P-5	80	124	80	45	65	37	67	1440	610	F5
DR500-05-045G/055P-5	38	168	93	55	86	45	68	1940	610	
DR500-05-055G/075P-5	119	198	113	75	100	55	68	2200	850	
DR500-06-075G/090P-5	142	200	142	90	121	75	68	3300	1275	F6
DR500-06-090G/110P-5	175	220	165	110	150	90	68	3850	1275	
DR500-07-110G/132P-5	220	240	215	132	175	110	75	4100	1800	F7
DR500-07-132G/160P-5	271	320	245	160	220	132	75	4600	1800	
DR500-07-160G/200P-5	290	350	265	200	250	160	75	5100	1800	
DR500-08-200G/220P-5	300	360	295	220	270	200	68	5782	2190	F8
DR500-08-220G/250P-5	330	360	325	250	300	220	68	6252	2190	
DR500-08-250G/280P-5	370	480	360	280	330	250	68	7866	2190	
DR500-09-280G/315P-5	430	520	420	315	385	280	75	9100	2700	F9
DR500-09-315G/355P-5	470	655	455	355	430	315	75	9900	2700	
DR500-09-355G/400P-5	522	700	505	400	470	355	75	10500	2700	
DR500-09-400G/450P-5	590	800	571	450	535	400	75	11500	2700	
DR500-09-450G/500P-5	721	820	710	500	600	450	75	12600	2700	
DR500-10-500G/560P-5	900	1000	790	560	680	500	75	13820	3600	C10
DR500-10-560G/630P-5	1080	1200	880	630	770	560	75	14850	3600	
DR500-11-630G/710P-5	1160	1750	1100	710	900	630	75	20000	7200	C11 ⁴
DR500-11-710G/800P-5	1450	2000	1200	800	1100	710	75	26000	7200	
DR500-11-800G/900P-5	1650	2200	1350	900	1200	800	75	32000	7200	

Note: Rated power is measured under rated voltage 500V

690V 3PH RATED VOLTAGE (ADAPT TO THE WORKING VOLTAGE RANGE 660~690V ±15%)

Model Code	Rated Value		General Load Application		Heavy Load Application		Noise Level	Heat Radiation	Air Volume	Dimension
	In(A)	Imax(A)	ILd(A)	PLd(kW)	Ihd (A)	Phd(kW)	dBA	W	m/h	
DR500/500L-04-015G/018P-6	22	44	21	18.5	18	15	60	550	610	F4
DR500/500L-04-018G/022P-6	26	54	25	22	22	18.5	60	660	610	
DR500/500L-04-022G/030P-6	35	64	33	30	27	22	60	890	610	
DR500/500L-04-030G/037P-6	44	70	41	37	35	30	60	1114	610	
DR500/500L-04-037G/045P-6	49	71	48	45	45	37	60	1140	610	
DR500/500L-04-045G/055P-6	61	104	58	55	52	45	60	1200	610	
DR500/500L-05-055G/075P-6	80	124	80	75	65	55	67	1440	610	F5
DR500/500L-05-075G/090P-6	98	168	93	90	86	75	68	1940	610	
DR500/500L-05-090G/110P-6	119	198	113	110	100	90	68	2200	850	
DR500/500L-06-110G/132P-6	142	200	142	132	121	110	68	3300	1275	F6
DR500/500L-06-132G/160P-6	175	220	165	160	150	132	68	3850	1275	
DR500/500L-07-160G/200P-6	220	240	215	200	175	160	75	4100	1800	F7
DR500/500L-07-200G/220P-6	271	320	245	220	220	200	75	4600	1800	
DR500/500L-07-220G/250P-6	290	350	265	250	250	220	75	5100	1800	
DR500/500L-08-250G/280P-6	300	360	295	280	270	250	68	5782	2190	F8
DR500/500L-08-280G/315P-6	330	360	325	315	300	280	68	6252	2190	
DR500/500L-08-315G/355P-6	370	480	360	355	330	315	68	7866	2190	
DR500/500L-09-355G/400P-6	430	520	420	400	385	355	75	9100	2700	F9
DR500/500L-09-400G/450P-6	470	655	455	450	430	400	75	9900	2700	
DR500/500L-09-450G/500P-6	522	700	505	500	470	450	75	10500	2700	
DR500/500L-09-500G/560P-6	590	800	571	560	535	500	75	11500	2700	
DR500/500L-09-560G/630P-6	721	820	710	630	600	560	75	12600	2700	
DR500/500L-10-630G/710P-6	900	1000	790	710	680	630	75	13820	3600	C10
DR500/500L-10-710G/800P-6	1080	1200	880	800	770	710	75	14850	3600	
DR500/500L-11-800G/1100P-6	1160	1750	1115	1100	900	800	75	20000	7200	C11 ⁴
DR500/500L-11-1100G/1250P-6	1450	2000	1250	1250	1114	1100	75	26000	7200	
DR500/500L-11-1250G/1400P-6	1650	2200	1400	1400	1250	1250	75	32000	7200	

Note: Rated power is measured under rated voltage 690V

MATRIX680

HIGH PERFORMANCE DRIVE

220V-240V	0.4KW-75KW
380V-500V	0.75KW-800KW
690V	45KW-1000KW

Servo Control



- Torque Resposne open Loop : 20 MS
- Torque Resposne Closed Loop : 5 MS
- Run Steadily with load at Ultra Low Speed of 0.01 HZ



Highest output frequency upto 1500 HZ



Support Multiple Encoders & Field Bus



High Precise Speed and Postion



Function of Fixed Lenth & Fixed Angle



Supports Pulse Input and Pulse output

High Overload Capacity

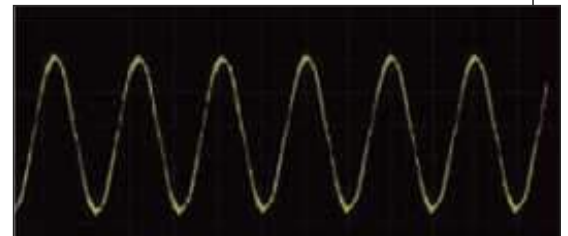

60S at 150% Rated Load

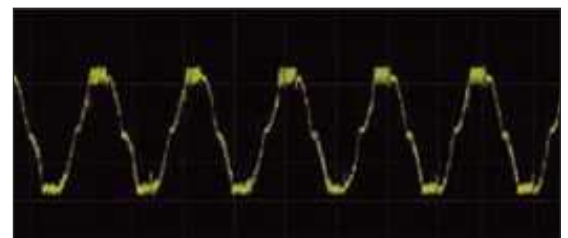

3S At 200% Rated Load



TECHNICAL DATA OF MATRIX 680

Item	Specification and Technical Data
Main Power Connection	Input voltage U1 220V/380V/500/690V±15% ;signal/three-phase power
	Input frequency f1 50...60Hz ±5Hz
	Output voltage U2 0...U1 (V)(The maximum output voltage equals the input power voltage.)
	Output frequency f2 0-1000Hz
	Carrier frequency 2-8 KHz (The device can intelligently and automatically make optimal adjustment according to load characteristics and drive temperature.)
	Input voltage unbalance degree Maximum: ±3% of rated inter-phase input voltage
	Efficiency ≈ 98% (when operating at rated power)
Basic Functions	Speed range 0-1000Hz (0~30000 rpm, 60000rpm is optional)
	Resolution of given speed Digital setting: 1RPM Analog setting: 0.025% of maximum RPM
	Control Mode SVC control / FVC vector control
	Starting speed 200% @ 0.25Hz@ SVC control 200% @0Hz@ FVC control
	Speed ratio 1 : 200 @ SVC control 1 : 3000 @ FVC control
	Steady-speed precision ±0.5% @ SVC control ±0.01% @ FVC control
	Overload capacity Heavy load application: 60s at 150% rated current @40°C. The time depends on the drive temperature under other conditions. General application: 60s at 120% rated current @40°C. The time depends on the drive temperature under other conditions.
	Torque boost Automatic torque boost. Manual torque boost 0.1%-30%
	Acceleration and deceleration curves straight-line or S-curve acceleration and deceleration mode Two acceleration time values. The acceleration and deceleration time range : 0.0s-650.00s
	Simple PLC function Achieve operation of up-to-16-stages speed(via built-in PLC or control terminals)
	Built-in PID Conveniently achieve the process control close-loop control system
Automatic voltage regulation (AVR) When the grid voltage changes, the device automatically maintains constant output voltage.	
Overvoltage and overcurrent stall control The current and voltage are automatically limited during running to avoid jump faults due to frequent over current and over voltage.	
Enhancements	Torque limiting and control The torque is automatically limited operating (to avoid frequent over current jumping fault due to too large torque).
	Protection function Output short circuit protection, input & output phase loss protection, over current protection, over voltage protection, under voltage protection, overheat protection, overload protection, brake chopper overload protection, brake chopper shortcircuit protection, brake resistor overload protection
	Non-stop during transient interruption Timing control function. The time range and precision is 0.0-6500.0(min).
I/O Input Output Interface	Command input mode Control keyboard input, control terminal input, bus communication input, which can be switched mutually.
	Speed reference mode Digital giving, analog voltage (current) giving, pulse giving, bus communication giving and PID giving, which are mutually switched.
	Input terminal (input) The followings are included in standard configuration : 6 (F0) / 7 (F1 and above) digital input terminals, where, DI6 (F0) DI7 (F1 and above)supports the maximum of 50 kHz high-speed pulse input. 2 (F0) / 3 (F1 and above) analog input terminals (where, at least 2 supports 0-10V voltage input or 0-20 mA or 4-20mA voltage input) The followings are extended as cards : 5 digital input terminals 2 analog input terminals, supporting input of -10V to+10V voltage (Optional)
	Output terminal (output) The followings are included in standard configuration: 1 high-speed pulse output terminal (supporting 0-50 kHz square signal output) 1 (F0) / 2 (F1 and above) digital output terminals 1 (F0) / 2 (F1 and above) relay output terminals 1 (F0) / 2 (F1 and above) analog output terminals (supporting 0-10V voltage output or 0- 20mA or 4-20 mA voltage output)

DIAGRAM OF MATRIX 680

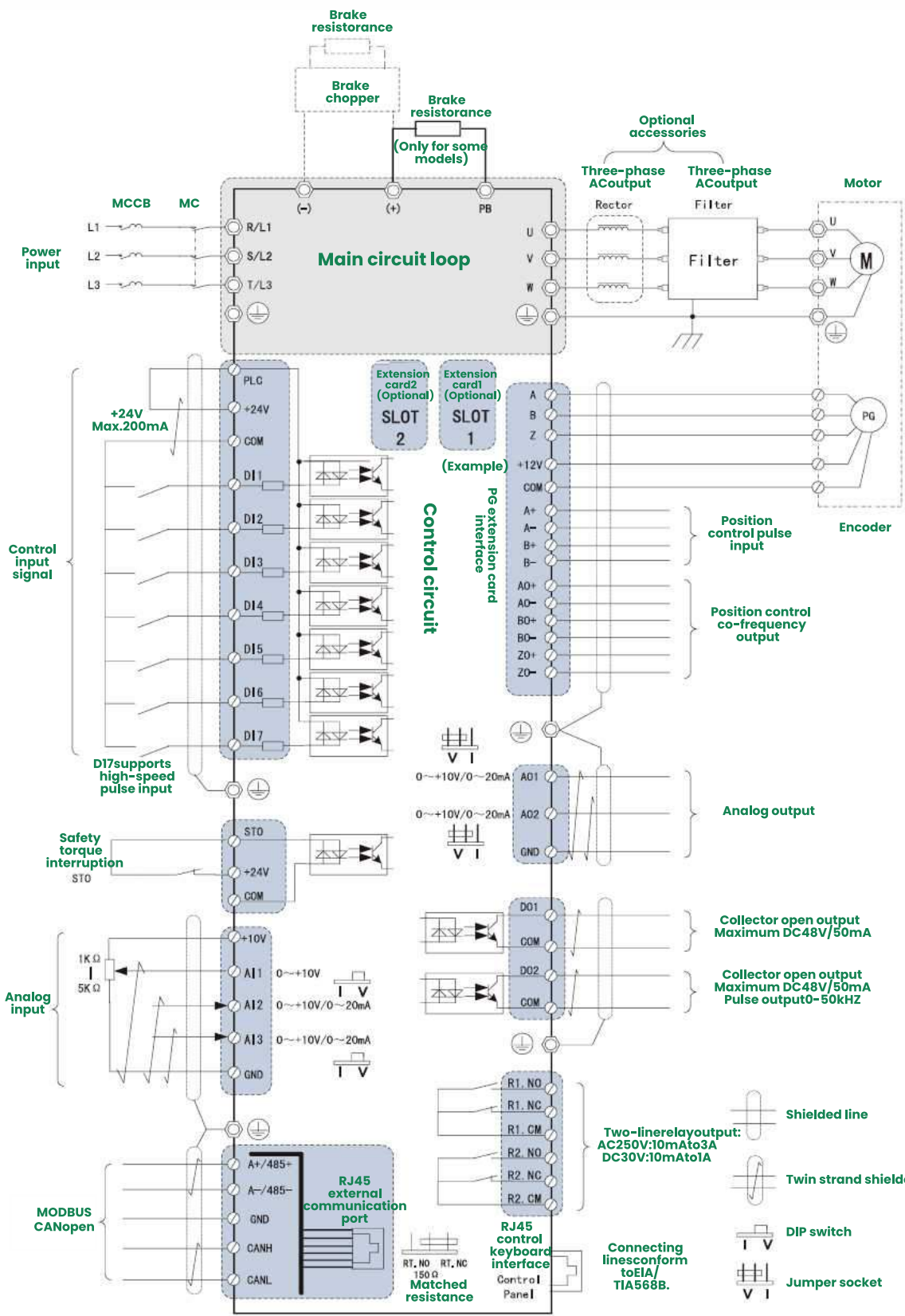

SELECTION OF DR 680

220V 3PH RATED VOLTAGE (ADAPT TO THE WORKING VOLTAGE RANGE 208 ~ 240V + 15%)

Model Code	Rated Value		General Load Application		Heavy Load Application		Noise Level	Heat Radiation	Air Volume	Dimension
	In(A)	Imax(A)	ILd(A)	PLd(kW)	Ihd (A)	Phd(kW)	dBA	W	m/h	
DR680-01-0K4G/0K7P-2B	5.2	7	5	0.75	2.5	0.37	45	40	89	F1
DR680-01-0K7G/1K5P-2B	6.3	9	6	1.5	4.2	0.75	45	76	89	
DR680-01-1K5G/2K2P-2B	10.5	15	9.8	2.2	5.6	1.5	45	97	89	
DR680-01-2K2G/4K0P-2B	18.2	25	17.5	4	14.5	2.2	45	172	130	
DR680-02-4K0G/5K5P-2B	26	36	25	5.5	17.6	4	45	325	130	F2
DR680-02-5K5G-2B	28	35	/	/	25	5.5	45	420	130	F2A
DR680-02A-5K5G/7K5P-2B	37	50	35	7.5	25	5.5	52	450	175	
DR680-02A-7K5G/011P-2B	41	57	38.6	11	35	7.5	52	450	175	
DR680-03-7K5G/011P-2B	41	57	38.6	11	35	7.5	57	550	306	F3
DR680-03-011G/015P-2B	63.5	89	61	15	48	11	57	890	306	F4
DR680-04-015G/018P-2	78	109	75	18.5	66	15	60	1114	610	
DR680-04-018G/022P-2	95	133	91	22	79	18.5	60	1140	610	
DR680-04-022G/030P-2	120	168	115	30	94	22	60	1200	610	
DR680-05-030G/037P-2	162	227	155	37	116	30	60	1440	610	F5
DR680-05-037G/045P-2	185	222	178	45	160	37	60	1940	610	
DR680-05-045G/055P-2	225	270	215	55	179	45	67	2200	850	
DR680-06-055G/075P-2	272	326	261	75	215	55	68	3300	1275	

Note: Rated power is measured under rated voltage 220V

380V 3PH RATED VOLTAGE (ADAPT TO THE WORKING VOLTAGE RANGE 380~460V +15%)

Model Code	Rated Value		General Load Application		Heavy Load Application		Noise Level	Heat Radiation	Air Volume	Dimension
	In(A)	Imax(A)	ILd(A)	PLd(kW)	Ihd (A)	Phd(kW)	dBA	W	m/h	
DR680/680L-01-0K7G/1K5P-3B	5.2	7	5	1.5	2.5	0.75	45	40	89	F1
DR680/680L-01-1K5G/2K2P-3B	6.3	9	6	2.2	4.2	1.5	45	76	89	
DR680/680L-01-2K2G/4K0P-3B	10.5	15	9.8	4	5.6	2.2	45	97	89	
DR680/680L-01-4K0G/5K5P-3B	14	20	13.5	5.5	10.5	4	45	172	89	
DR680/680L-01-5K5G/7K5P-3B	18.2	25	17.5	7.5	14.5	5.5	45	210	130	F2
DR680/680L-02-7K5G/011P-3B	26	36	25	11	17.6	7.5	45	325	130	
DR680/680L-02-011G-3B	28	35	26	15	25	11	45	420	130	F2A
DR680/680L-02A-011G/015P-3B	37	50	35	15	25	11	52	470	175	
DR680/680L-02A-015G/018P-3B	41	57	38.6	18.5	35	15	52	550	175	
DR680/680L-03-015G/018P-3B	41	57	38.6	18.5	35	15	57	550	306	F3
DR680/680L-03-018G/022P-3B	48	67	46	22	41	18.5	57	660	306	
DR680/680L-03-022G/030P-3B	63.5	89	61	30	48	22	57	890	306	
DR680/680L-04-030G/037P-3/B	78	109	75	37	66	30	60	1114	610	F4
DR680/680L-04-037G/045P-3/B	95	133	91	45	79	37	60	1140	610	
DR680/680L-04-045G/055P-3/B	120	168	115	55	94	45	60	1200	610	
DR680/680L-05-055G/075P-3/B	162	227	155	75	116	55	60	1440	610	
DR680/680L-05-075G/090P-3/B	185	240	178	90	160	75	60	1940	610	F5
DR680/680L-05-090G/110P-3/B	225	270	215	110	179	90	67	2200	850	
DR680/680L-06-110G/132P-3	272	326	261	132	215	110	68	3300	1275	F6
DR680/680L-06-132G/160P-3	320	384	310	160	259	132	68	3850	1275	
DR680/680L-07-160G/200P-3	375	450	387	200	314	160	75	4100	1800	F7
DR680/680L-07-200G/220P-3	450	540	427	220	387	200	75	4600	1800	
DR680/680L-07-220G/250P-3	487	584	450	250	427	220	75	5100	1800	
DR680/680L-08-250G/280P-3	546	628	525	280	481	250	68	5782	2190	F8
DR680/680L-08-280G/315P-3	624	718	600	315	550	280	68	6252	2190	
DR680/680L-08-315G/355P-3	686	789	660	355	616	315	68	7866	2190	
DR680/680L-09-355G/400P-3	760	874	720	400	650	355	75	9100	2700	
DR680/680L-09-400G/450P-3	865	995	810	450	720	400	75	9900	2700	F9
DR680/680L-09-450G/500P-3	950	1093	870	500	810	450	75	10500	2700	
DR680/680L-09-500G/560P-3	1100	1265	980	560	870	500	75	11500	2700	
DR680/680L-09-560G/630P-3	1200	1380	1060	630	980	560	75	12600	2700	C10
DR680/680L-10-630G/710P-3	1350	1450	1320	710	1200	630	75	14500	3600	
DR680/680L-10-710G/800P-3	1500	1600	1450	800	1320	710	75	16800	3600	

Note: Rated power is measured under rated voltage 380V

500V 3PH RATED VOLTAGE (ADAPT TO THE WORKING VOLTAGE RANGE 480~525V ±15%)

Model Code	Rated Value		General Load Application		Heavy Load Application		Noise Level	Heat Radiation	Air Volume	Dimension
	In(A)	Imax(A)	ILd(A)	PLd(kW)	Ihd (A)	Phd(kW)	dBA	W	m/h	
DR680-04-015G/018P-5	35	64	33	18.5	27	15	60	890	610	F4
DR680-04-018G/022P-5	44	70	41	22	35	18.5	60	1114	610	
DR680-04-022G/030P-5	49	71	48	30	45	22	60	1140	610	
DR680-04-030G/037P-5	61	104	58	37	52	30	60	1200	610	
DR680-05-037G/045P-5	80	124	80	45	65	37	67	1440	610	F5
DR680-05-045G/055P-5	38	168	93	55	86	45	68	1940	610	
DR680-05-055G/075P-5	119	198	113	75	100	55	68	2200	850	
DR680-06-075G/090P-5	142	200	142	90	121	75	68	3300	1275	F6
DR680-06-090G/110P-5	175	220	165	110	150	90	68	3850	1275	
DR680-07-110G/132P-5	220	240	215	132	175	110	75	4100	1800	F7
DR680-07-132G/160P-5	271	320	245	160	220	132	75	4600	1800	
DR680-07-160G/200P-5	290	350	265	200	250	160	75	5100	1800	
DR680-08-200G/220P-5	300	360	295	220	270	200	68	5782	2190	F8
DR680-08-220G/250P-5	330	360	325	250	300	220	68	6252	2190	
DR680-08-250G/280P-5	370	480	360	280	330	250	68	7866	2190	
DR680-09-280G/315P-5	430	520	420	315	385	280	75	9100	2700	F9
DR680-09-315G/355P-5	470	655	455	355	430	315	75	9900	2700	
DR680-09-355G/400P-5	522	700	505	400	470	355	75	10500	2700	
DR680-09-400G/450P-5	590	800	571	450	535	400	75	11500	2700	
DR680-09-450G/500P-5	721	820	710	500	600	450	75	12600	2700	
DR680-10-500G/560P-5	900	1000	790	560	680	500	75	13820	3600	C10
DR680-10-560G/630P-5	1080	1200	880	630	770	560	75	14850	3600	
DR680-11-630G/710P-5	1160	1750	1100	710	900	630	75	20000	7200	C11 ⁴
DR680-11-710G/800P-5	1450	2000	1200	800	1100	710	75	26000	7200	
DR680-11-800G/900P-5	1650	2200	1350	900	1200	800	75	32000	7200	

Note: Rated power is measured under rated voltage 500V

690V 3PH RATED VOLTAGE (ADAPT TO THE WORKING VOLTAGE RANGE 660~690V ±15%)

Model Code	Rated Value		General Load Application		Heavy Load Application		Noise Level	Heat Radiation	Air Volume	Dimension
	In(A)	Imax(A)	ILd(A)	PLd(kW)	Ihd (A)	Phd(kW)	dBA	W	m/h	
DR680/680L-04-015G/018P-6	22	44	21	18.5	18	15	60	550	610	F4
DR680/680L-04-018G/022P-6	26	54	25	22	22	18.5	60	660	610	
DR680/680L-04-022G/030P-6	35	64	33	30	27	22	60	890	610	
DR680/680L-04-030G/037P-6	44	70	41	37	35	30	60	1114	610	
DR680/680L-04-037G/045P-6	49	71	48	45	45	37	60	1140	610	
DR680/680L-04-045G/055P-6	61	104	58	55	52	45	60	1200	610	
DR680/680L-05-055G/075P-6	80	124	80	75	65	55	67	1440	610	F5
DR680/680L-05-075G/090P-6	98	168	93	90	86	75	68	1940	610	
DR680/680L-05-090G/110P-6	119	198	113	110	100	90	68	2200	850	
DR680/680L-06-110G/132P-6	142	200	142	132	121	110	68	3300	1275	F6
DR680/680L-06-132G/160P-6	175	220	165	160	150	132	68	3850	1275	
DR680/680L-07-160G/200P-6	220	240	215	200	175	160	75	4100	1800	F7
DR680/680L-07-200G/220P-6	271	320	245	220	220	200	75	4600	1800	
DR680/680L-07-220G/250P-6	290	350	265	250	250	220	75	5100	1800	
DR680/680L-08-250G/280P-6	300	360	295	280	270	250	68	5782	2190	F8
DR680/680L-08-280G/315P-6	330	360	325	315	300	280	68	6252	2190	
DR680/680L-08-315G/355P-6	370	480	360	355	330	315	68	7866	2190	
DR680/680L-09-355G/400P-6	430	520	420	400	385	355	75	9100	2700	F9
DR680/680L-09-400G/450P-6	470	655	455	450	430	400	75	9900	2700	
DR680/680L-09-450G/500P-6	522	700	505	500	470	450	75	10500	2700	
DR680/680L-09-500G/560P-6	590	800	571	560	535	500	75	11500	2700	
DR680/680L-09-560G/630P-6	721	820	710	630	600	560	75	12600	2700	
DR680/680L-10-630G/710P-6	900	1000	790	710	680	630	75	13820	3600	C10
ES580/580L-10-710G/800P-6	1080	1200	880	800	770	710	75	14850	3600	
ES580/580L-11-800G/1100P-6	1160	1750	1115	1100	900	800	75	20000	7200	C11 ⁴
ES580/580L-11-1100G/1250P-6	1450	2000	1250	1250	1114	1100	75	26000	7200	
ES580/580L-11-1250G/1400P-6	1650	2200	1400	1400	1250	1250	75	32000	7200	

Note: Rated power is measured under rated voltage 690V

MATRIX350

SMART CONVEYOR DRIVE

220V IPH | 0.4-2.2KW
380V 3PH | 0.75-4KW



Pumping



Moving



Processing



About Product

”



Standard configuration STO safety torque off function



Support SVC/ scalar control



Support permanent magnet synchronous motor/asynchronous motor control



Standard C3 filter



Large screen LCD or LED keyboard can be connected externally



All DI terminals both support PNP & NPN input, DI4 supports 60kHz high-speed input



Standard configuration of magnetic flux braking function



The carrier frequency can be adjusted intelligently according to the temperature

TECHNICAL DATA OF MATRIX 350

Item	Specification and Technical Data
Main Power Connection	Input voltage U1 220V/380V/500/690V±15% ;signal/three-phase power
	Input frequency f1 50...60Hz ±5Hz
	Output voltage U2 0...U1 (V)(The maximum output voltage equals the input power voltage.)
	Output frequency f2 0-1000Hz
	Carrier frequency 2-8 KHz (The device can intelligently and automatically make optimal adjustment according to load characteristics and drive temperature.)
	Input voltage unbalance degree Maximum: ±3% of rated inter-phase input voltage
	Efficiency ≈ 98% (when operating at rated power)
Basic Functions	Speed range 0-1000Hz (0~30000 rpm, 60000rpm is optional)
	Resolution of given speed Digital setting: 1RPM Analog setting: 0.025% of maximum RPM
	Control Mode SVC control / FVC vector control
	Starting speed 200% @ 0.25Hz@ SVC control 200% @0Hz@ FVC control
	Speed ratio 1 : 200 @ SVC control 1 : 3000 @ FVC control
	Steady-speed precision ±0.5% @ SVC control ±0.01% @ FVC control
	Overload capacity Heavy load application: 60s at 150% rated current @40°C. The time depends on the drive temperature under other conditions. General application: 60s at 120% rated current @40°C. The time depends on the drive temperature under other conditions.
	Torque boost Automatic torque boost. Manual torque boost 0.1%-30%
	Acceleration and deceleration curves straight-line or S-curve acceleration and deceleration mode Two acceleration time values. The acceleration and deceleration time range : 0.0s-650.00s
	Simple PLC function Achieve operation of up-to-16-stages speed(via built-in PLC or control terminals)
	Built-in PID Conveniently achieve the process control close-loop control system
Automatic voltage regulation (AVR) When the grid voltage changes, the device automatically maintains constant output voltage.	
Overvoltage and overcurrent stall control The current and voltage are automatically limited during running to avoid jump faults due to frequent over current and over voltage.	
Enhancements	Torque limiting and control The torque is automatically limited operating (to avoid frequent over current jumping fault due to too large torque).
	Protection function Output short circuit protection, input & output phase loss protection, over current protection, over voltage protection, under voltage protection, overheat protection, overload protection, brake chopper overload protection, brake chopper shortcircuit protection, brake resistor overload protection
	Non-stop during transient interruption Timing control function. The time range and precision is 0.0-6500.0(min).
I/O Input Output Interface	Command input mode Control keyboard input, control terminal input, bus communication input, which can be switched mutually.
	Speed reference mode Digital giving, analog voltage (current) giving, pulse giving, bus communication giving and PID giving, which are mutually switched.
	Input terminal (input) The followings are included in standard configuration : 6 (F0) / 7 (F1 and above) digital input terminals, where, DI6 (F0) DI7 (F1 and above)supports the maximum of 50 kHz high-speed pulse input. 2 (F0) /3 (F1 and above) analog input terminals (where, at least 2 supports 0-10V voltage input or 0-20 mA or 4-20mA voltage input) The followings are extended as cards : 5 digital input terminals 2 analog input terminals, supporting input of -10V to+10V voltage (Optional)
	Output terminal (output) The followings are included in standard configuration: 1 high-speed pulse output terminal (supporting 0-50 kHz square signal output) 1 (F0) /2 (F1 and above) digital output terminals 1 (F0) /2 (F1 and above) relay output terminals 1 (F0) /2 (F1 and above) analog output terminals (supporting 0-10V voltage output or 0- 20mA or 4-20 mA voltage output)

DIAGRAM OF MATRIX 350

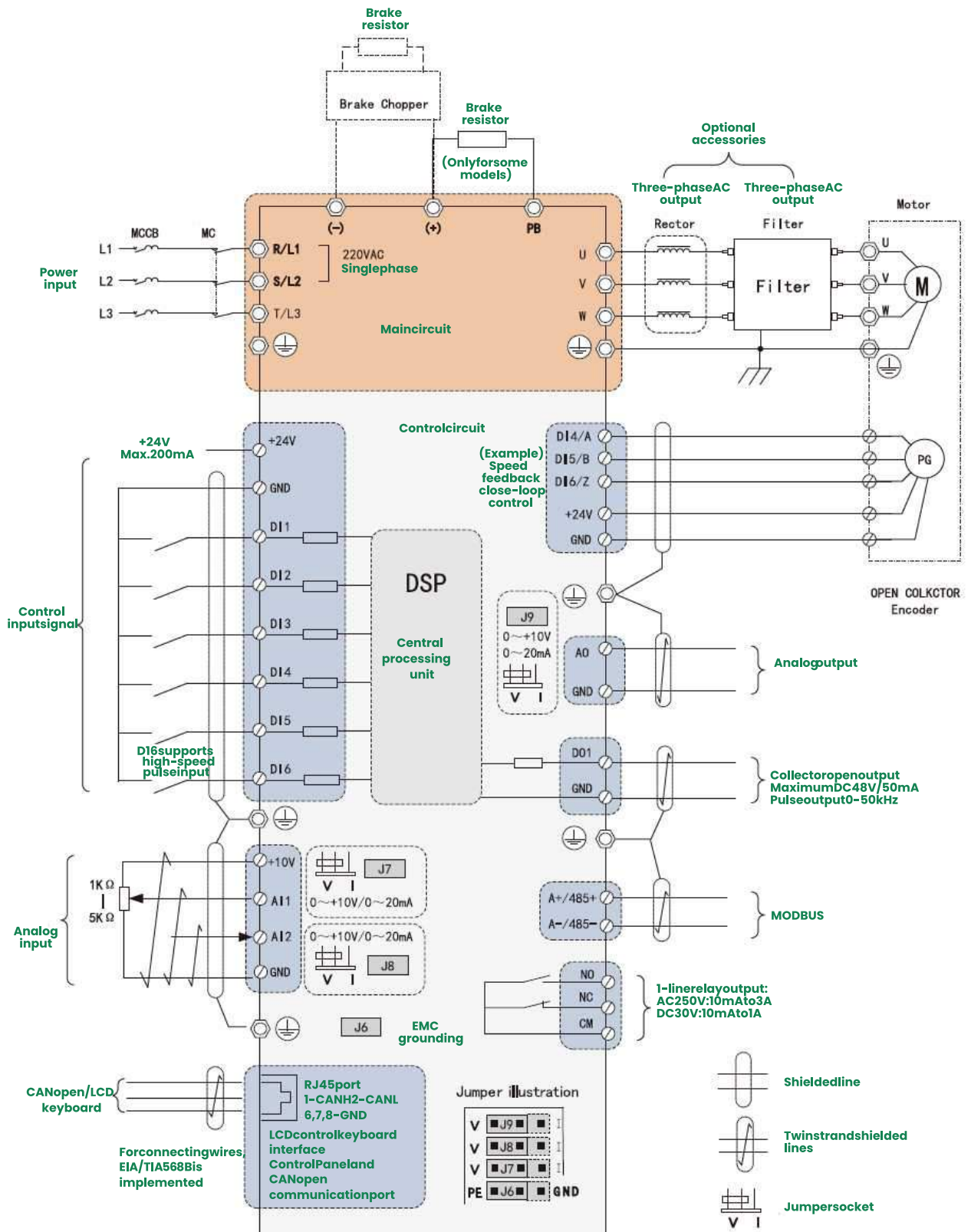

SELECTION OF DR 350



- Small size and compact
- Easy commissioning, optional intelligent LCD keyboard
- Support SVC/ FVC vector control
- Support permanent magnet synchronous motor/asynchronous motor control
- Smart PID function
- With 6 digital input terminals
- Support both speed & torque control

220V 3PH RATED VOLTAGE (ADAPT TO THE WORKING VOLTAGE RANGE 208 ~ 240V + 15%)

Model Code	Rated Value		General Load Application		Heavy Load Application		Noise Level	Heat Radiation	Air Volume	Dimension
	In(A)	Imax(A)	ILd(A)	PLd(kW)	lhd (A)	Phd(kW)	dBA	W	m/h	
DR350-F0-0K4G/0K7P-2B	5.2	6	4.5	0.75	2.5	0.37	40	40	25	FO ⁺³⁾
DR350-F0-0K7G/1K5P-2B	6.3	7.5	7	1.5	4.5	0.75	40	65	25	
DR350-F0-1K5G/2K2P-2B	9.5	11	8.5	2.2	7	1.5	40	80	25	
DR350-F0-2K2G-2B	10	12	/	/	9	2.2	40	92	25	FO ⁺³⁾

Note: Rated power is measured under rated voltage 220V

220V 1PH RATED VOLTAGE (ADAPT TO THE WORKING VOLTAGE RANGE 208 ~ 240V + 15%)

Model Code	Rated Value		General Load Application		Heavy Load Application		Noise Level	Heat Radiation	Air Volume	Dimension
	In(A)	Imax(A)	ILd(A)	PLd(kW)	lhd (A)	Phd(kW)	dBA	W	m/h	
DR350-F0-0K4G/0K7P-1B	4.8	6	4.5	0.75	2.5	0.37	40	40	25	FO ⁺³⁾
DR350-F0-0K7G/1K5P-1B	7.5	10	7	1.5	4.5	0.75	40	65	25	
DR350-F0-1K5G/2K2P-1B	9	11.5	8.5	2.2	7	1.5	40	80	25	
DR350-F0-2K2G-1B	10	12	/	/	9	2.2	40	92	25	

Note: Rated power is measured under rated voltage 220V

380V 3PH RATED VOLTAGE (ADAPT TO THE WORKING VOLTAGE RANGE 380 ~ 240V + 15%)

Model Code	Rated Value		General Load Application		Heavy Load Application		Noise Level	Heat Radiation	Air Volume	Dimension
	In(A)	Imax(A)	ILd(A)	PLd(kW)	lhd (A)	Phd(kW)	dBA	W	m/h	
DR350-F0-0K7G/1K5P-3B	5.2	6	5	1.5	2.5	0.75	40	40	25	FO ⁺³⁾
DR350-F0-1K5G/2K2P-3B	6.3	7.5	6	2.2	4	1.5	40	76	25	
DR350-F0-2K2G/4K0P-3B	9.5	11	9	4	5	2.2	40	97	25	
DR350-F0-4K0G-3B	10	12	/	/	8	4	40	125	25	FO ⁺³⁾

Note: Rated power is measured under rated voltage 380V

MATRIX900

SOLAR DRIVE

220V | 0.75KW-2.2KW
400V | 0.75KW-22KW



Support 220-440VAC



Hybrid Power Input



Water Tank Control Mode



Supporting Solar & grid Power for Day & Night Mode



MAX SOLAR Power Tracking Efficiency Reaches 99.9% MPPT



Multi Meter Display

Current , voltage, KW/h,
water Flow



Multi Protection

Pump over Temperature ,
pump Dry run , pump overload



DC Support

250V to 600V

APPLICATIONS MACRO



SOLAR PUMPS



BOOSTER PUMPS



FRESH WATER PUMPS



SWEGAE PUMPS



CONVEYORS



FEEDING PUMPS



FAN & BLOWERS

TECHNICAL DATA OF MATRIX 900 |▶

Basic Function	Specification and Technical Data
Control System	High performance of current vector control technology to realize 3 phase asynchronous motor control
Drive Performance	High efficiency driving for induction motor and synchronous motor
Maximum Frequency	Vector Control: 0~500Hz ~ V/F Control: 0~500Hz
Carrier Frequency	0.5kHz~16kHz; the carrier frequency will be automatically adjusted according to the load characteristics
Input Frequency Resolution	Digital Setting: 0.01Hz
	Analog Setting: maximum frequency x0.025%
Control Mode	Open Loop Vector Control(SVC)
	V/F Control
Startup Torque	G Type: 0.5Hz/150%(SVC); 0Hz/180%(FVC) P Type: 0.5Hz/100%
Speed Range	1: 100(SVC)
Speed Tracking	Prevent overload, overcurrent, and overvoltage caused by motor stall
Speed Stabilizing Precision	+0.5%(SVC)
Over Load Capability	G Type: 150% rated current 60 seconds; 180% rated current 3 seconds;
	P Type: 120% rated current 60 seconds; 150% rated current 3 seconds
Torque Boost	Auto Torque Boost Function; Manual torque boost 0.1%~30.0%
V/F Curve	Linear V/F, multi-point V/F and square V/F curve (power of 1.2, 1.4, 1.6, 1.8, 2)
V/F Separation	In 2 ways: separation, semi separation
Acc. / dec Curve	Straight line or S curve acceleration and deceleration mode.
	Four kinds of acceleration and deceleration time. Acceleration and deceleration time range between 0.0s to 6500s.
DC Brake	DC Brake Frequency: 0.00Hz to maximum frequency. Brake time: 0.0s to 36.0s
	Brake current value: 0.0% to 100.0%.
Jog Control	Jog Frequency Range: 0.00Hz~50.00Hz.
	Jog Acceleration/deceleration Time 0.0s~6500.0s.
Simple PLC and Multi-Speed Running	It can realize at maximum of 16 segments speed running via the built-in PLC or control terminal.
Built-in PID	It is easy to realize process-controlled closed loop control system
Auto Voltage Regulation (AVR)	It can keep constant output voltage automatically in the case of change of network voltage.

TECHNICAL DATA OF MATRIX 900 |▶

Basic Function	Specification and Technical Data
Over-voltage/current Stall Control	It can limit the running voltage/current automatically and prevent frequent over-voltage/current tripping during the running process
Quick Current Limit	Minimize the over-current fault, protect normal operation of the Inverter
Torque Limit & Control	"Excavators" characteristics, automatically limit torque during operation, prevent frequent over-current tripping.
	Closed loop vector mode can realize the torque control.

Personalized	Specification and Technical Data
Mains loss Ride Through	When instantaneous power off, voltage reduction is compensated through load feedback energy, which could make Inverter keep running in a short period of time.
Rapid Current Limit	To avoid Inverter frequently over-current fault.
Timing Control	Timing control function: set time range 0Min~6500.0Min
Running Command Channel	Three types of channels: operation panel reference, control terminal reference and serial communication port reference. These channels can be switched in various modes.
Command Source	Operation panel reference, control terminal reference, and serial COM port reference. It can be switched in various ways.
Frequency Source	There are totally eleven types of frequency sources, such as digital reference, analog voltage reference, analog current reference, pulse reference, and serial port reference. It can be switched in various ways.
Input Terminal	Standard: 5 Digital input terminals 2 Analog input terminals 1 Support 0-10V voltage input or 0~20mA current input.
Output Terminal	Standard: 2 Digital output terminals 1 Relay output terminal, which can be expanded into 2 channels 1 Analog output terminals, support 0~10V output voltage;
Keypad Potentiometer	Equipped with Keypad potentiometer or coding potentiometer

TECHNICAL DATA OF MATRIX 900 |▶

Environment	Specification and Technical Data
Altitude	Below 1000m
Ambient Temperature	10 °C to +40 °C (Derating use when under ambient temperature of 40 °C to 50 °C)
Humidity	Less than 95%RH, without condensing
Vibration	Less than 5.9m/s (0.6)

Display	Specification and Technical Data
Protection Function	It can implement power-on motor short-circuit detection, output phase loss protection, overcurrent protection, over voltage protection, under voltage protection, overheating protection and overload protection.
Using Place	Indoor; and be free from direct sunlight, dust, corrosive gas , combustible gas, oil smoke, vapor,drip or salt.

NAMEPLATE / V900

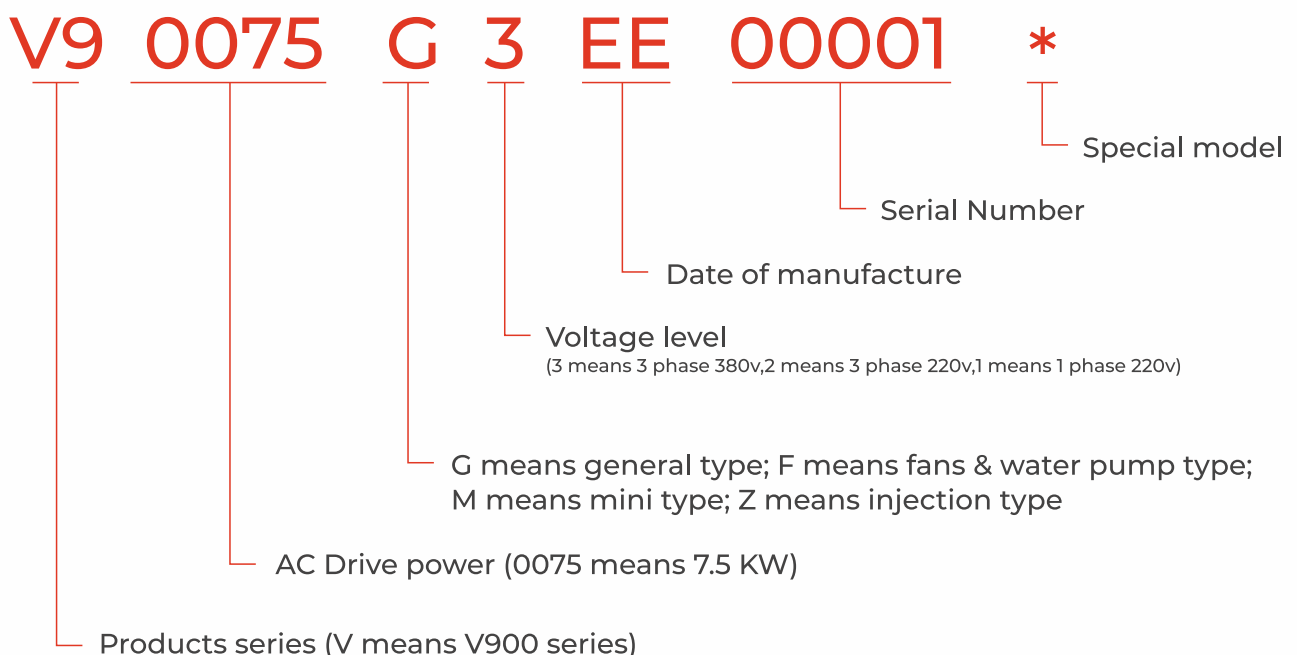

SELECTION OF DR 900

DIMENSION

No.	W(mm)	D(mm)	H(mm)
A00M	86	123	153
A00	86	141	170
A01	96	171	180
A02	114	192	228
A03	160	182	290
A04	193	217	328

INSTALLATION SIZE

No.	W(mm)	D(mm)	H(mm)
A00M	76	143	4.5
A00	75	157	5
A01	83.6	176	5
A02	98.7	214.5	5
A03	143	269	6.5
A04	172	305	8.5

PRODUCTS SERIES

Inverter Model	Power	Adapted motor		Rated Output Current (A)	Frame
		KW	HP		
V900-0007M1	220V Single phase input	0.75	1	4	A00M
V900-0015M1		1.5	2	7	A00M
V900-0007M3	380V Three phase input	0.75	1	2.5	A00M
V900-0015M3		1.5	2	3.7	A00M
V900-0022M3		2.2	3	5.1	A00M
V900-0007G1	220V Single phase input	0.75	1	4	A00
V900-0015GT		1.5	2	7	A00
V900-0022G1		2.2	3	10	A01
V900-0007G3	380V Three phase input	0.75	1	2.5	A00
V900-0015G3		1.5	2	3.7	A00M
V900-0022G3		2.2	3	5.1	A00M
V900-0040G3		4	5	8.5	A01
V900-0055G3		5.5	7.5	13	A02
V900-0075G3		7.5	10	16	A02
V900-0110G3		11	15	25	A03
V900-0150G3		15	20	32	A03
V900-0185G3		18.5	25	38	A04
V900-0220G3		22	30	45	A04

MATRIX880

Harmonics Mitigation
2) 98.2% Filter Efficiency

ACTIVE FRONT END

HVAC



Over Heating



Over Current



Over Voltage



Short Circuit



Digital Torque Control



Dancer Control



Low harmonics



Traverse Function



DC Reactor

380V-690V

1.5KW-450KW



APPLICATION - ENGINE



FLYING
SHEAR



ENGINE
TESTING



ASRS



PUMPS



HIGH SPEED
MACHINE

DIAGRAM OF MATRIX 880

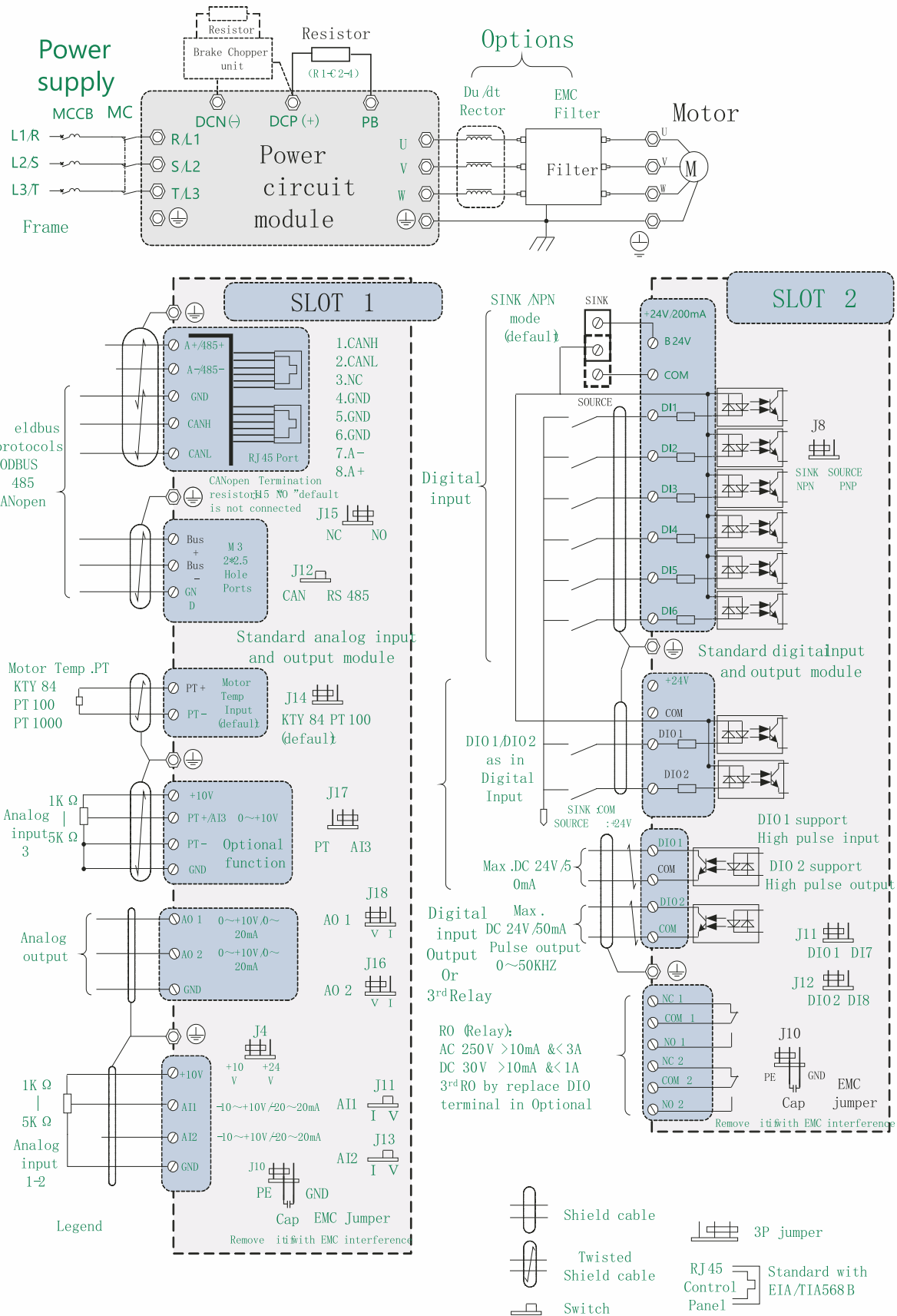

MATRIX9000

MEDIUM VOLTAGE VARIABLE FREQUENCY DRIVE

3KV,6.6KV,11KV
250KW to 20000 KW



Power Unit By pass Operation



Restart with Speed Tracking



Safe resonance Avoidance



Automatic Flux Optimaization



Start with full torque at low Speed



Surge Absorption Capacity for Power Protection



Power Loss ride though and Power failure Recovery Features



Infaliable Power Supplied by Control Power Supply

APPLICATIONS MICRO



POWER INDUSTRY



CEMENT



COAL



WATER TREATMENT



MINING INDUSTRY



PETROCHEMICAL



METALLURGICAL

DIAGRAM OF MATRIX 9000

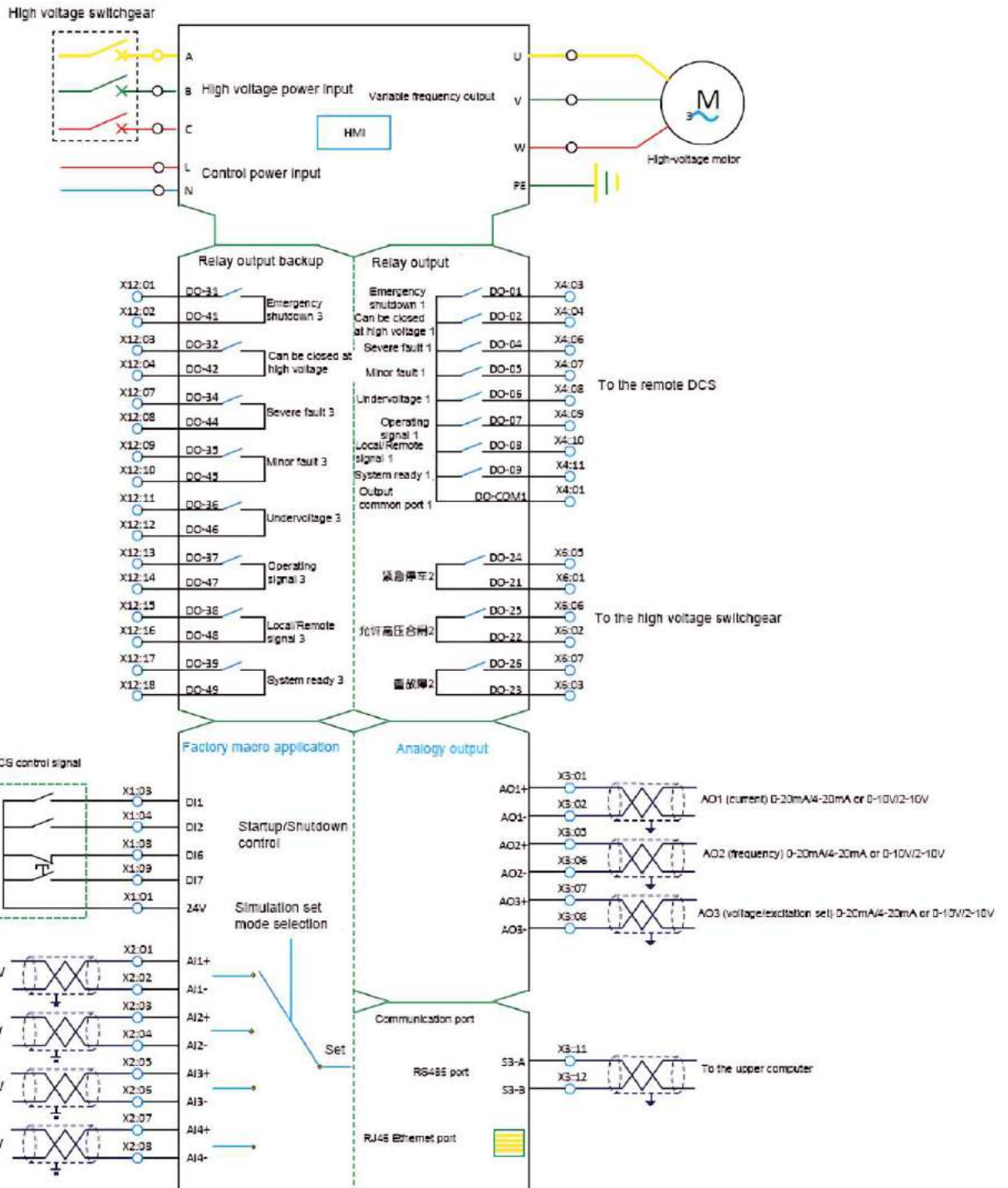

APPLICATIONS

ADVANTAGEOUS INDUSTRY APPLICATIONS

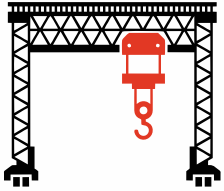

LIFTING MACHINERY

- Quick Start, Strong Torque, Vibration Relief
- Brake Prevents Sliding
- Stable torque boosts elevator reliability and comfort, crucial in construction lifts.
- Complete safeguards prevent malfunctions.
- Compact design, optional built-in brake (below 90kW).
- Smart drive simplifies tasks, saves time and costs.
- Smart LCD keyboard enables real-time monitoring and interaction.
- The voltage operation range is wide (-15% to +15%).



Bridge Crane



Tower Crane



Hoist

TYPICAL APPLICATIONS

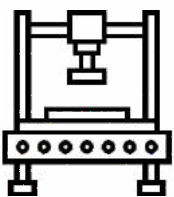

METAL & STRONG PROCESSING

- Stable, precise motion: low frequency, strong torque.
- Rapid deceleration on power loss prevents prolonged inertia rotation, enhancing safety.
- Strong overload tolerance (200% load for 1 sec) and excellent overvoltage protection, especially for punching.
- IP40 protection, sealed circuit design, multiple conformal coatings, robust adaptability.
- Smart drive function, which can be used in most servo applications.
- Smart drive for easy operations, cost and time savings in commissioning and maintenance.
- Smart LCD keyboard, real-time info monitoring, user-friendly interaction.
- Minimal speed fluctuation upon sudden load.
- Capable of receiving various signal sources



Machine tools



Rotary cutter for the wood



Punch of the metal

TYPICAL APPLICATIONS

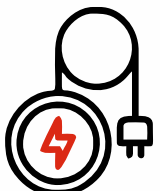

CABLES, WINDING MACHINERY

- Low frequency, high torque for reel startup, empty or full.
- Quick response, stability in startup, stop, acceleration, and deceleration.
- Precise speed control, constant tension, stable pendulum.
- IP40 protection, sealed circuit, shields metal dust effectively.
- F3+ models reduce power harmonics, no extra accessories for space-saving.
- Smartdrive simplifies setup, aids maintenance, saving time and labor costs.
- LCD keyboard: Real-time key info monitoring, seamless interaction.



Coating machine



Straight wire drawing machine

TYPICAL APPLICATIONS



FLUID MACHINERY

- Auto-set: Industry parameters and V/F curve, no pro tuning needed, time-saving.
- Compatible with synchronous motors
 - Energy greatly Used with synchronous motor, down sizing and light weight, saving.
 - Used with synchronous motor, down sizing and light weight, saving equipment room.
- Equipment room Built-in reactor for F3 and above models
- No optional accessories needed: Space-saving, efficient EMI control.
- Good human-machine interface
- Real-time monitoring of key parameters; real-time and multi-line LCD display.
- Quick startup: Post-power loss rotation search for easy startup.
- Max energy savings: Minimal power usage for equivalent torques.



Air Compressor



Fans & pumps



High Speed Maglev Blower

Compact Elevator Drive

ELEVATOR MOTOR

- Gearless Permanent Magnet Motors
- Geared Induction Motors
- No motor manufacturer allegiance for full motor flexibility

ELEVATOR ENCODER – OPTIONAL FEEDBACK

- Incremental Encoders
- EnDat Rotary Encoders (EnDat 2.1 & 2.2) with simulated encoder output
- SinCos Rotary Encoder with simulated Encoder output

FLEXIBILITY

- Control of Geared and Gearless elevator systems in a single product
- Open loop or Closed loop vector (with incremental encoder) control of standard IM motors
- Open loop or Closed loop (with SinCos/EnDat encoder control of PM motors

COMFORTABLE RIDE

- Includes 5 independent S-Ramps allowing fine tuning of ride performance and jerk free travel
- Short floor operation reduces carriage travel time
- High motor switching frequency (max 32kHz) for quiet motor operation
- Dedicated motor brake control algorithm for safe and smooth operation of the motor brake

ADVANCED FEATURES

- Anti-Rollback (Open and closed loop operation)
- Rescue mode operation (Sine wave or square wave UPS), with easiest direction measurement for UPS longevity.
- Modbus RTU and CANopen as standard
- Full load operation up to 50°C with no de-rating
- Safe Torque Off function built in as standard
- Brake release monitoring (In compliance with EN81-20 protection against unintended car movement)

EASY TO USE

- Easy-learn parameter structure and programming
- Factory parameter settings suited to simple elevator applications for fast start up
- Drive setup using familiar elevator units
- Standstill motor autotune – no shaft rotation – no rope removal required

”

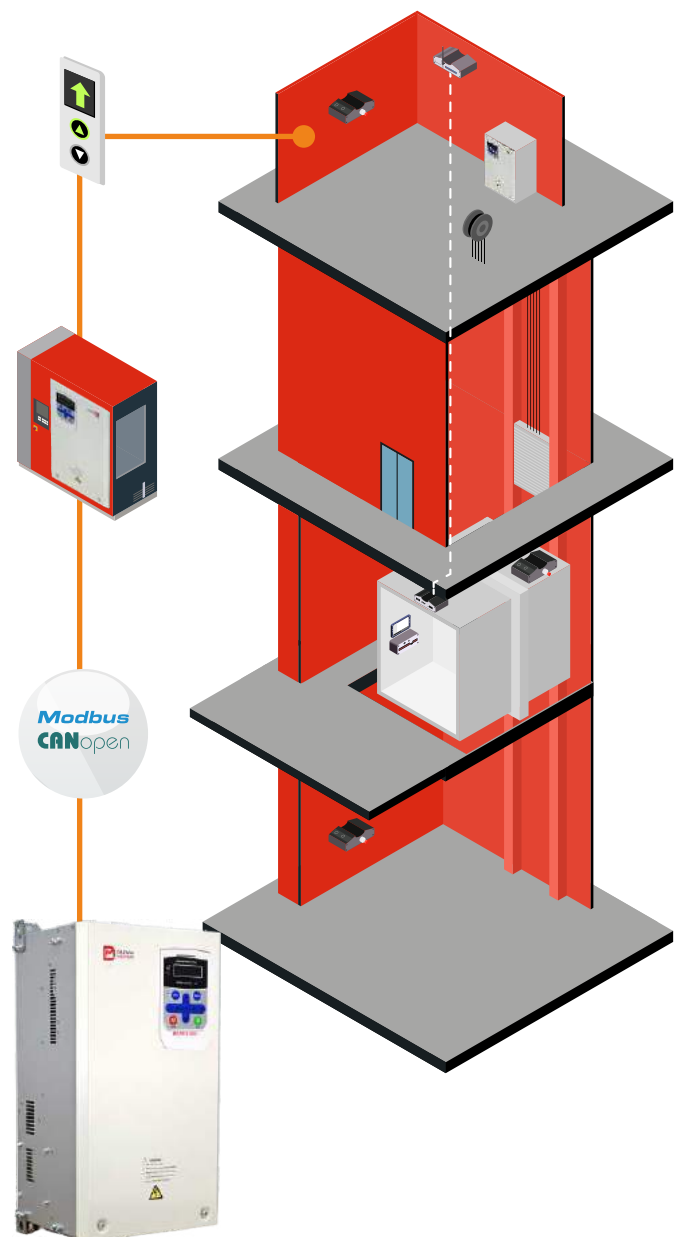

Darwindrive Eco Pump

Flexible pump station control

“ Pump Prime with Burst Pipe Detection

Pump prime mode allows starting of the pump in a safely controlled manner, to ensure consistent filling and pressurisation of pipe work and warnings are ignored during priming to systems. Low pressure warnings are ignored during priming to allow the system to prime correctly, whilst a failsafe timeout prevents the pump from continuing to run in the event of a failure to prime. This helps to prevent the effects of water hammering (such as bursting water pipes) or damage to fountain /sprinkler heads.

The time limit, set for pump prime mode to complete, means that the pressure in the system must reach the minimum level within the set time. Failure of the system to pressurise would indicate a leak or burst pipe within the pump system and result in the Darwindrive Eco Pump shutting down the pump. During normal operation the system pressure is still continuously monitored against the minimum level so that a burst pipe during normal operation will likewise result in the drive tripping 'low pressure' and shutting

FEATURES



Total Control



Simple Connection



Flexible Solution



Consistent Flow



Reduced Downtime



AVOID PUMP DOWNTIME

Blockage Detect/Clear

Optidrive Eco Pump can detect pump blockages and trigger a programmed cleaning cycle to automatically clear them, preventing downtime.

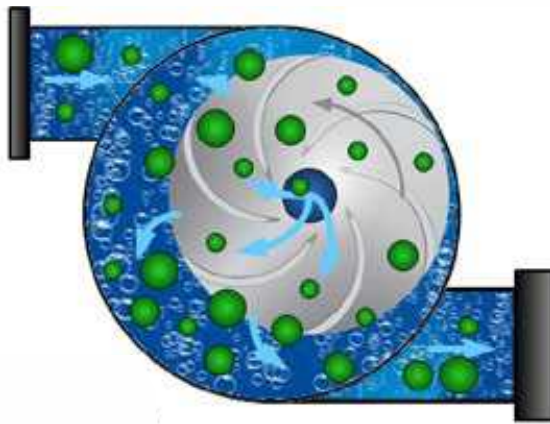

NORMAL OPERATION

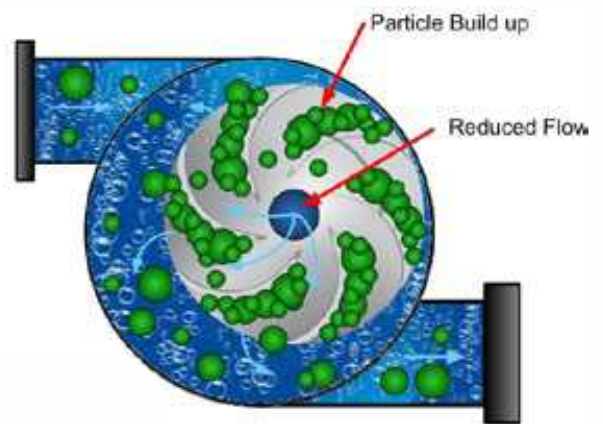

REDUCED OPERATION



Dry Run Protection

Optidrive Eco Pump can evaluate a pump's speed/power and shut it off or warn when the pump starts to run dry, protecting it from heat/friction damage.

Motor Preheat Function

Optidrive Eco Pump features a motor preheat function to help ensure moisture is not permitted to collect on the motor in periods of inactivity and prior to motor start up. In addition, the motor preheat function can be used to keep condensation from developing on the motor as the motor cools down immediately following a stop. The feature is fully configurable, meaning the pump can be always available the instant it is required.

Pump Stir Cycle

Triggered by a settable period of inactivity, a configurable cleaning cycle can be run to clear sediment, ensuring the pump is ready to run when needed.

SUMMARY

- All drives operate at variable speed for maximum energy efficiency.
- Operating time (Hours Run) is automatically balanced and duty pumps rotated.
- Automatic system reconfiguration in the event of a pump fault (including the master pump).
- Continued system operation when drives are individually powered off (including the master drive).
- Communication and +24V control voltage shared between drives via a standard RJ45 patch lead.
- Independent maintenance indicators for each pump.
- Any pump can be switched to Hand operation at the touch of a button, and will automatically rejoin the network when switched back to Auto.
- For waste water applications each pump can be set for blockage/ragging detection and activate an automatic de-ragging/pump cleaning cycle.
- Optional mains isolator with lock-off for safe pump maintenance.
- Optiflow function configured through simple parameter set-up and intelligent drive self configuration.

CONTACT US



**DARWIN
MOTION**

High Power ■ High Energy Saving

 + 91 8956113099, + 91 8956113100

 Office No. 212, Xion Mall Hinjewadi, Pune 411057

 sales@darwinmotion.com

 www.darwinmotion.com